

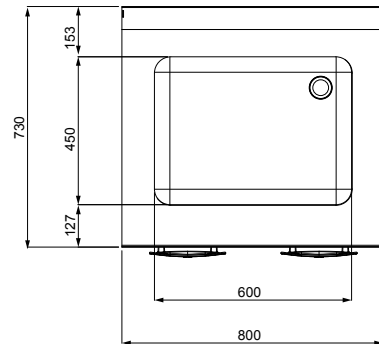

mm | 600 x 450 x 300 h

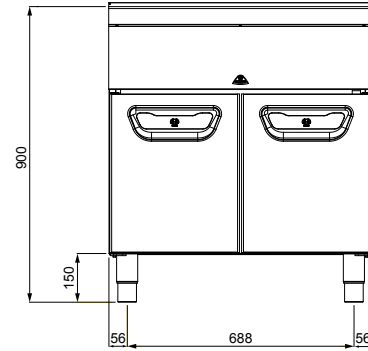

Kg | 58



OPTIONAL

Gruppo miscelatore • Mixer tap • Robinet mélangeur • Mischbatterie

CARATTERISTICHE TECNICHE E FUNZIONALI

Piano di lavoro in acciaio inox AISI 304 con spessore 20/10, pannelli frontali e laterali in acciaio inox AISI 304, con finitura Scotch Brite. Vasca stampata con ampi raggi in acciaio lucidato. Piedini regolabili in altezza.
OPTIONAL: funzionale rubinetto a miscelatore di alta qualità.

TECHNICAL AND FUNCTIONAL FEATURES

Worktop from AISI 304 stainless steel of 20/10 thickness, front and side panels from AISI 304 stainless steel and Scotch Brite finishing. Pressed sink with large rounded edges in polished steel. Height adjustable feet.
OPTIONAL: high quality functional mixer tap.

CARACTÉRISTIQUES TECHNIQUES ET FONCTIONNELLES

Plan de travail en acier inoxydable AISI 304 avec une épaisseur de 20/10, panneaux avant et latéraux en acier inoxydable AISI 304, finition Scotch Brite. Cuve moulée arrondie en acier poli. Pieds réglables en hauteur.
OPTIONAL : robinet mélangeur fonctionnel haute qualité.

TECHNISCHE UND FUNKTIONELLE EIGENSCHAFTEN

Arbeits Tisch aus rostfreiem Edelstahl AISI 304, Stärke 20/10, Vorder- und Seitenwände aus rostfreiem Edelstahl AISI 304, Ausführung Scotch Brite. Tiefgezogenes Becken mit weiten Abrundungen aus poliertem Stahl. Höhenverstellbare Stützfüße.
OPTIONAL: Funktionaler Mischer von hoher Qualität.